

# ALADIN

*Design Piero Lissoni*



## ALADIN DOUBLE SWING FRAME



# ALADIN

Design Piero Lissoni

## ALADIN DOUBLE SWING FRAME MONO

**Aladin Double Swing Frame Mono** è una porta doppia a battente prodotta su misura, con stipite telescopico e cerniere a perno regolabili.

Un vetro è applicato su un lato di un telaio, in modo da avere una faccia con superficie planare e l'altra con superficie arretrata rispetto alla cornice perimetrale d'alluminio. Il vetro può essere monolitico temperato 6 mm oppure stratificato 3 + 3 mm temperato, disponibile in una vastissima gamma di finiture.

Tutti i vetri sono certificati secondo le normative di sicurezza ANSI Z97.1 e UNI EN12150.

Sono disponibili anche pannelli in gres con diverse finiture.

E' possibile montare diversi tipi di serratura e scegliere tra maniglia o pomolo che, come lo stipite, sono forniti nella stessa finitura del telaio.

Disponibile anche nella versione filo soffitto.

**Aladin Double Swing Frame Mono** is a double custom-made swing door with telescopic jamb and adjustable pivot hinges.

A glass is applied on one side of the frame, so as to have a face with a flush surface, whilst the other surface is rebated from the perimeter aluminium frame.

The glass can be monolithic tempered 6 mm in a single piece or tempered laminated 3 + 3 mm, available in a wide range of finishes.

All glasses are certified according to the safety regulation ANSI Z97.1 and UNI EN12150.

Panels in stoneware with different finishes are available too.

It is possible to assemble different kind of locks and choose between handle and knob which are provided, like the jamb, in the same finishes as the frame.

Available also in the version with frame flush with the ceiling.



codice  
code

**ASWFM2**

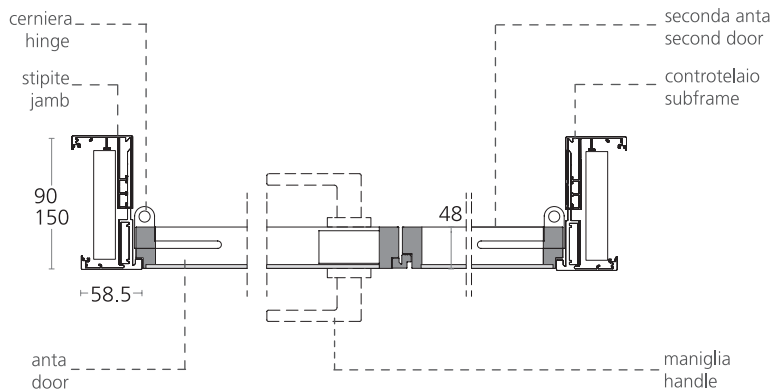

GLAS  
ITALIA

Sede, direzione commerciale e showroom: Via Cavour 29 - 20846 Macherio (MB)  
tel. +39 039.23 23 202 ra - fax +39 039.23 23 212 - e-mail: glas@glasitalia.com - www.glasitalia.com

# ALADIN

Design Piero Lissoni

## ALADIN DOUBLE SWING FRAME DUO

**Aladin Double Swing Frame Duo** doppia a battente prodotta su misura, con stipite telescopico e cerniere a perno regolabili. Dei vetri temperati spessore 4 mm sono applicati su entrambe le facce di un telaio in alluminio, disponibile in cinque finiture, in modo da formare un volume con una camera d'aria interna. I vetri, disponibili in un'ampia gamma di finiture, sono certificati secondo le normative di sicurezza ANSI Z97.1 e UNI EN12150. Sono disponibili anche pannelli in gres o in legno, con diverse finiture ed essenze. E' possibile montare diversi tipi di serratura e scegliere tra maniglia o pomolo che, come lo stipite, sono forniti nella stessa finitura del telaio. Disponibile anche nella versione filo soffitto.

**Aladin Double Swing Frame Duo** is a double custom made swing door with telescopic jamb and adjustable pivot hinges. Tempered glasses 4 mm thick are applied on both faces of an aluminium frame, available in five different finishes so as to form a volume with an internal air chamber. The glasses are available in a wide range of finishes and they are certified according to the safety regulation ANSI Z97.1 and UNI EN12150. Panels in stoneware and in wood with different finishes and essences are available too. It is possible to assemble different kind of locks and choose between handle and knob which are provided, like the jamb, in the same finishes as the frame. Available also in the version with frame flush with the ceiling.



codice  
code

**ASWFD2**

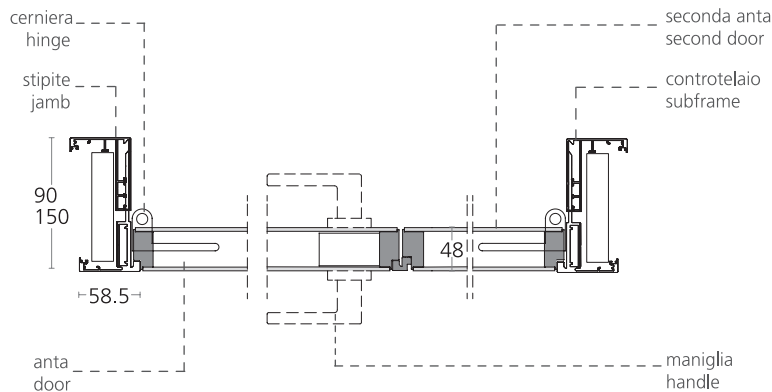

GLAS  
ITALIA

Sede, direzione commerciale e showroom: Via Cavour 29 - 20846 Macherio (MB)  
tel. +39 039.23 23 202 ra - fax +39 039.23 23 212 - e-mail: [glas@glasitalia.com](mailto:glas@glasitalia.com) - [www.glasitalia.com](http://www.glasitalia.com)

# ALADIN

Design Piero Lissoni

## ALADIN DOUBLE SWING FRAME MONO ALADIN DOUBLE SWING FRAME DUO

### MANIGLIE PORTA DOPPIO BATTENTE / HANDLES DOUBLE SWING DOOR

Maniglia senza blocco /  
Handle without block

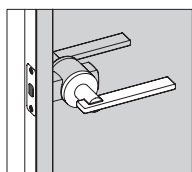

codice  
code  
LSBA

Maniglia con chiusura privacy /  
Handle with privacy lock

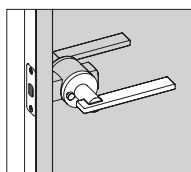

codice  
code  
LCPA

Maniglia con chiave /  
Handle with key lock

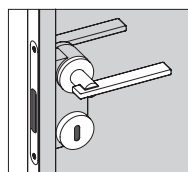

codice  
code  
LCCA

Maniglia con cilindro /  
Handle with cylinder lock

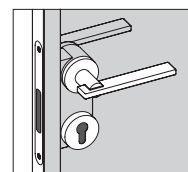

codice  
code  
LCYA

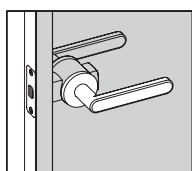

codice  
code  
LSBB

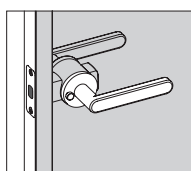

codice  
code  
LCPB

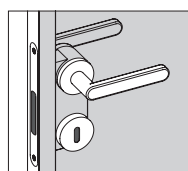

codice  
code  
LCCB

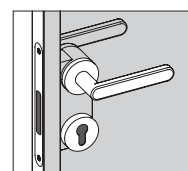

codice  
code  
LCYB

### POMOLI PORTA DOPPIO BATTENTE / KNOBS DOUBLE SWING DOOR

Pomolo senza blocco /  
Knob without block

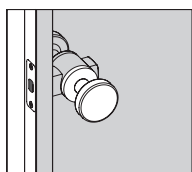

codice  
code  
PSB

Pomolo con chiusura privacy /  
Knob with privacy lock

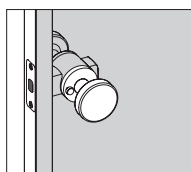

codice  
code  
PCP

Pomolo con chiave /  
Knob with key lock

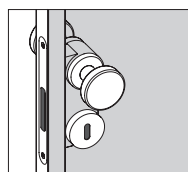

codice  
code  
PCC

Pomolo con cilindro /  
Knob with cylinder lock

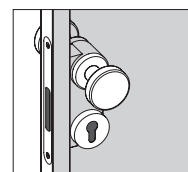

codice  
code  
PCY