

# SHERAZADE

*Design Piero Lissoni*



## SHERAZADE POCKET PATCHWORK



# SHERAZADE

Design Piero Lissoni

## SHERAZADE POCKET PATCHWORK

Le ante **Sherazade Pocket Patchwork**, con le medesime caratteristiche di Sherazade Slide Patchwork, sono prodotte su misura e perfettamente integrabili nei più diffusi sistemi di porte scorrevoli a scomparsa senza stipite, quali Scigno Essential® Scorrevole ed Eclisse® SyntesisLine.

Le due versioni ad anta singola e ad anta doppia possono essere fornite con o senza serratura.

A richiesta vengono forniti anche i controtelai per cartongesso e intonaco.

The **Sherazade Pocket Patchwork** doors, with the same features as Sherazade Slide Patchwork, are custom-made and can be integrated with the most common systems of sliding pocket doors without jamb, such as Scigno Essential® Scorrevole and Eclisse® SyntesisLine.

The two versions, single or double door, are available with or without lock.

Subframes for plasterboard or brick walls can be provided on request.

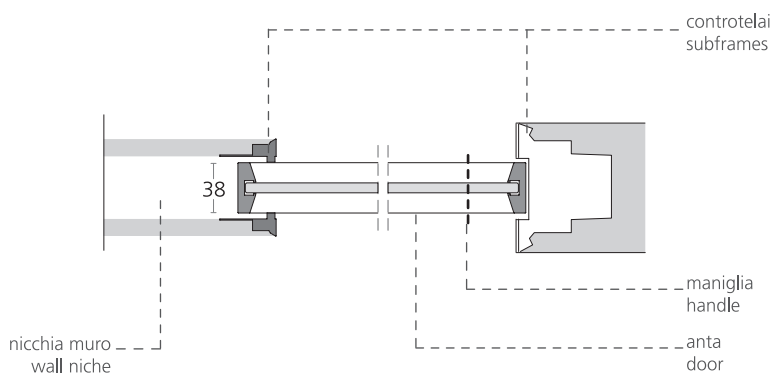
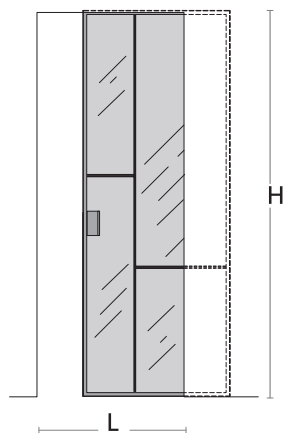

# SHERAZADE

Design Piero Lissoni

## SHERAZADE POCKET PATCHWORK

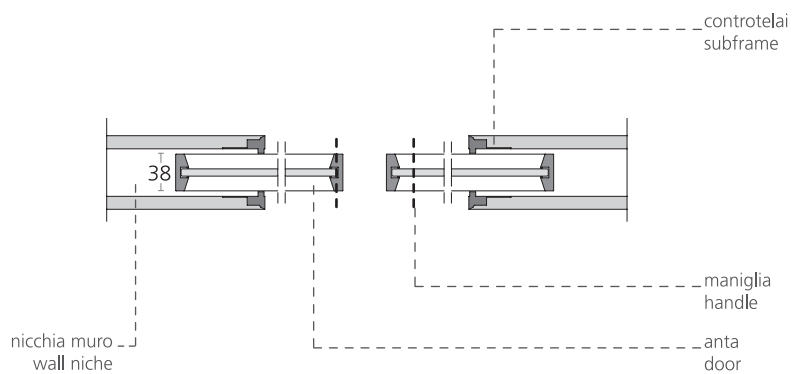
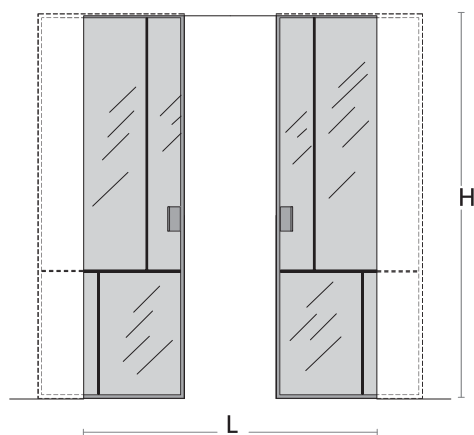

GLAS  
ITALIA

Sede, direzione commerciale e showroom: Via Cavour 29 - 20846 Macherio (MB)  
tel. +39 039.23 23 202 ra - fax +39 039.23 23 212 - e-mail: [glas@glasitalia.com](mailto:glas@glasitalia.com) - [www.glasitalia.com](http://www.glasitalia.com)

# SHERAZADE

Design Piero Lissoni

## SHERAZADE POCKET PATCHWORK

CONFIGURAZIONE PORTA SCOMPARSA ANTA SINGOLA /  
CONFIGURATION SINGLE POCKET DOOR

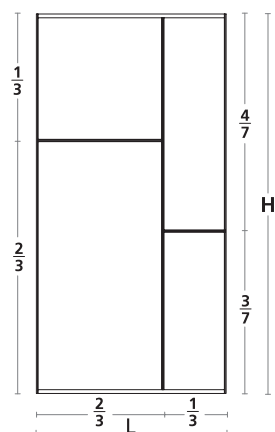

codice  
code  
**SPO1P01**

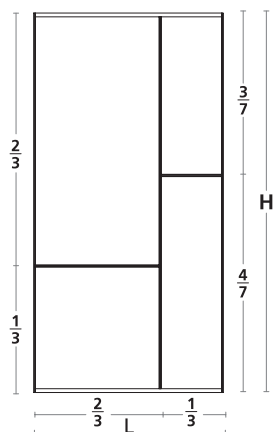

codice  
code  
**SPO1P02**

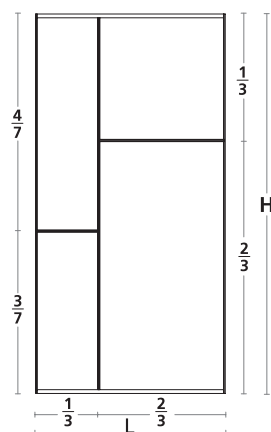

codice  
code  
**SPO1P03**

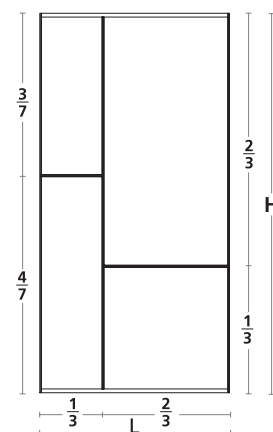

codice  
code  
**SPO1P04**

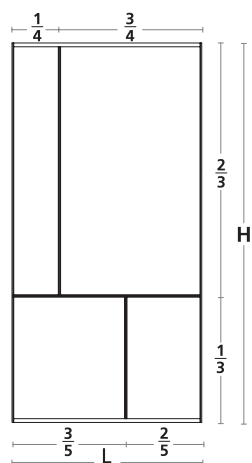

codice  
code  
**SPO1P05**

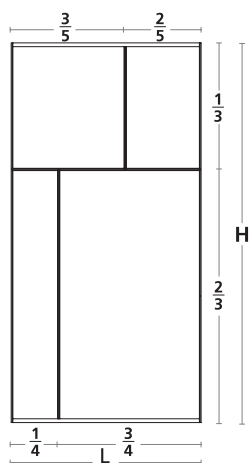

codice  
code  
**SPO1P06**

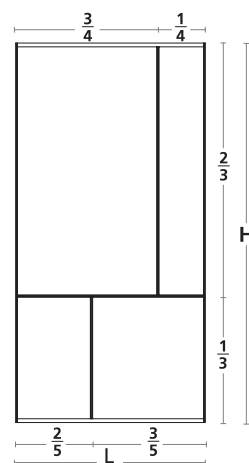

codice  
code  
**SPO1P07**

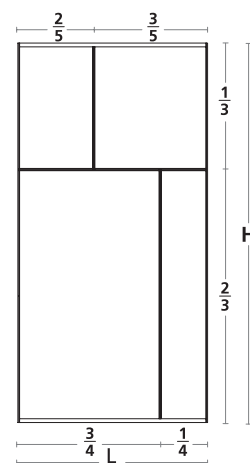

codice  
code  
**SPO1P08**

# SHERAZADE

Design Piero Lissoni

## SHERAZADE DOUBLE POCKET PATCHWORK

### CONFIGURAZIONE PORTA SCOMPARSA ANTA DOPPIA / CONFIGURATION DOUBLE POCKET DOOR

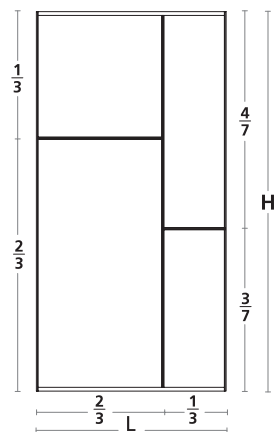

codice  
code  
**SPO2P01**

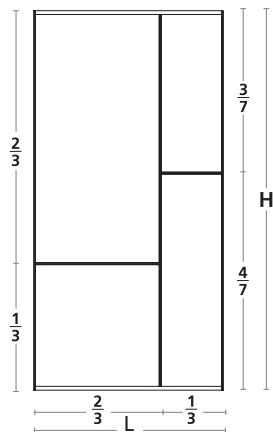

codice  
code  
**SPO2P02**

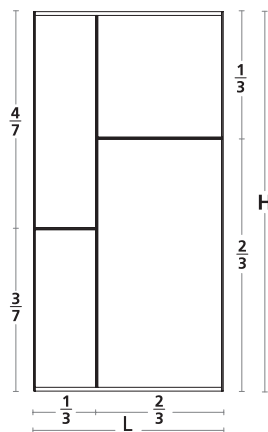

codice  
code  
**SPO2P03**

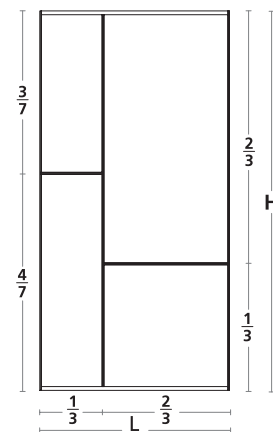

codice  
code  
**SPO2P04**

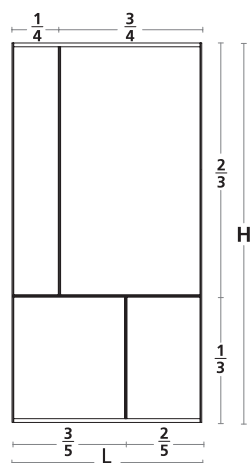

codice  
code  
**SPO2P05**

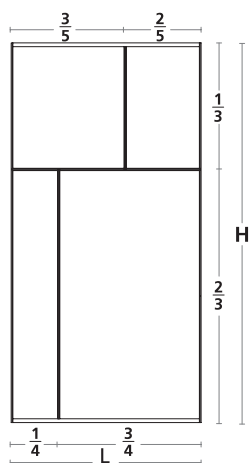

codice  
code  
**SPO2P06**

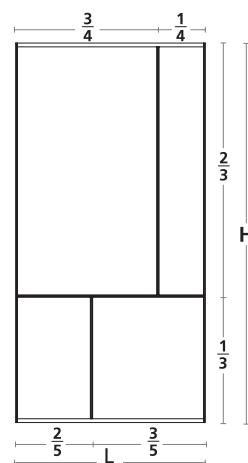

codice  
code  
**SPO2P07**

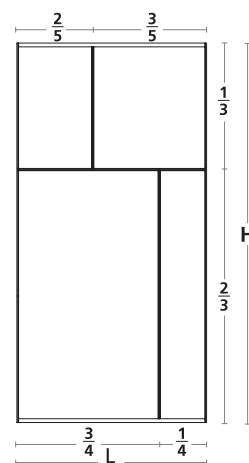

codice  
code  
**SPO2P08**

# SHERAZADE

Design Piero Lissoni

## SHERAZADE POCKET PATCHWORK

### MANIGLIE PORTA SCOMPARSA ANTA SINGOLA / HANDLES SINGLE POCKET DOOR

Maniglia senza supporto /  
Handle without support

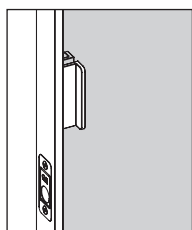

codice  
code  
MSSSP

Maniglia con supporto /  
Handle with support

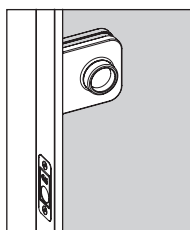

codice  
code  
MCSSP

Maniglia con nottolino /  
Handle with revolving plug

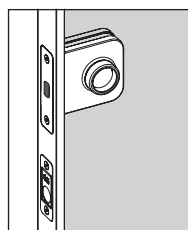

codice  
code  
MCNSP

Maniglia con chiave /  
Handle with key lock

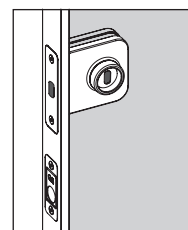

codice  
code  
MCCSP

### MANIGLIE PORTA SCOMPARSA ANTA DOPPIA / HANDLES DOUBLE POCKET DOOR

Maniglia doppia senza supporto /  
double handle without support

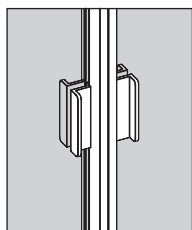

codice  
code  
M2SSSP

Maniglia doppia con supporto /  
Double handle with support

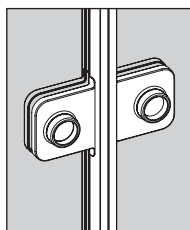

codice  
code  
M2CSSP

Maniglia doppia con nottolino /  
Double handle with revolving plug

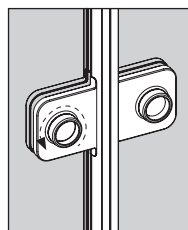

codice  
code  
M2CNSP

Maniglia doppia con chiave /  
Double handle with key lock

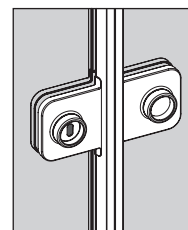

codice  
code  
M2CCSP