

# SHERAZADE

*Design Piero Lissoni*



## SHERAZADE DOUBLE SWING SLIM JAMBS PATCHWORK



# SHERAZADE

Design Piero Lissoni

## SHERAZADE DOUBLE SWING SLIM JAMBS PATCHWORK

**Sherazade Swing Slim Jambs Patchwork** una porta doppia a battente prodotta su misura, che si distingue per la grande pulizia formale, con mini-profili di battuta telescopici e cerniere a perno regolabili. Una porta dalla grande eleganza e cura dei dettagli, la cui superficie è ripartita in quattro riquadri, in cui possono essere posizionati diversi tipi di cristalli temperati monolitici mm. 6 o stratificati mm. 3+3. Questi pannelli, tramite una guarnizione, vengono inseriti al centro di profili d'alluminio, forniti in cinque diverse finiture. I vetri, disponibili in una vastissima gamma di finiture, sono certificati secondo le normative di sicurezza ANSI Z97.1 e UNI ENI 2150 (ad eccezione di 533. retinato). Sono disponibili anche pannelli in gres o in legno, con diverse finiture ed essenze. È possibile montare tre tipi di serratura (senza blocco, con cilindro, con nottolino) e scegliere tra maniglia o pomolo che, come i profili di battuta, sono forniti nella stessa finitura del telaio. L'intero gruppo maniglia è trattato con una speciale vernice igienizzante (testata secondo la norma ISO 22196:2011) che, contrastando la proliferazione batterica, garantisce la massima igiene e pulizia delle superfici.

**Sherazade Swing Slim Jambs Patchwork** is a custom-made double swing door, exemplified by its great formal cleanliness, with slim telescopic profiles and adjustable hinges. A door of great elegance and attention to detail, whose surface is divided into four panes, featuring different types of monolithic tempered glass 6mm or laminated 3+3mm. These panels are fitted by means of a gasket in the center of aluminum profiles, available in five finishes and supported by a gasket. The glass is available in a very wide range of finishes and is certified according to the ANSI Z97.1 and UNI ENI 2150 safety standards (except for 533. Retinato). There are stoneware and wood veneer doors in different finishes as well. It is possible to mount three types of closure (without lock, with cylinder twist lock, with pawl) and a choice of handles or knobs which, like the stop profiles, are supplied in the same color as the frame. The entire handle unit is treated with a special sanitizing coating (tested according to ISO 22196: 2011 standard) which, by countering the bacterial proliferation, guarantees maximum hygiene and surface cleanliness.

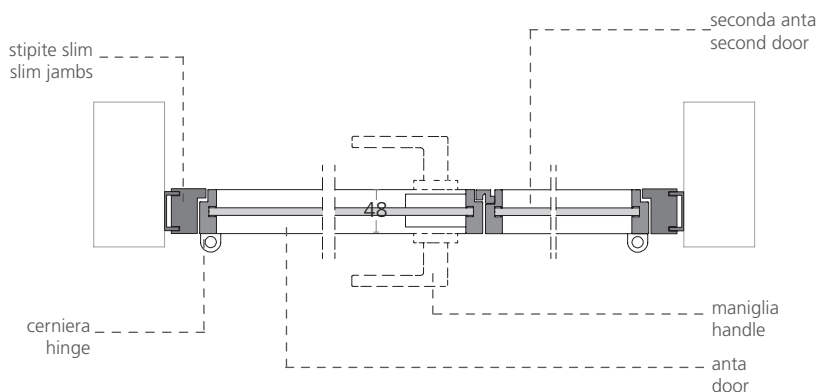
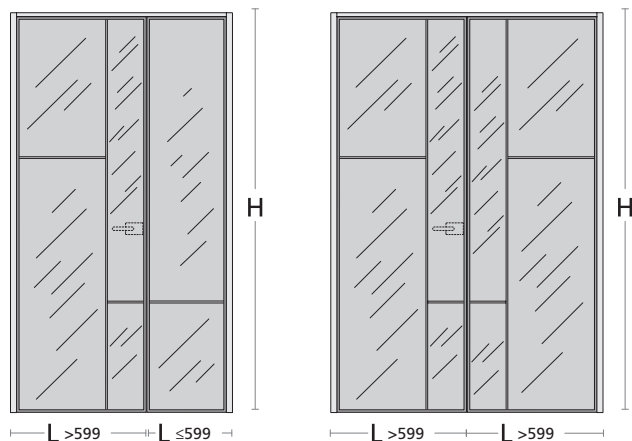

# SHERAZADE

Design Piero Lissoni

## SHERAZADE DOUBLE SWING SLIM JAMBS PATCHWORK

### CONFIGURAZIONE PORTA BATTENTE / CONFIGURATION SWING DOOR

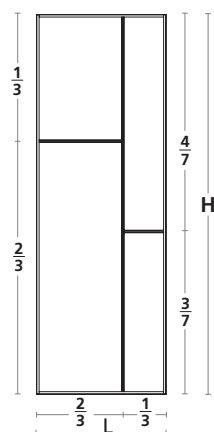

codice  
code  
**SSJFP01D**

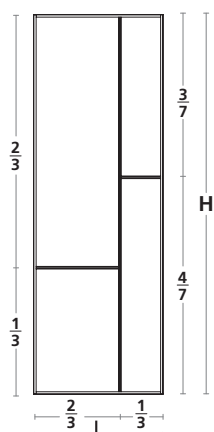

codice  
code  
**SSJFP02D**

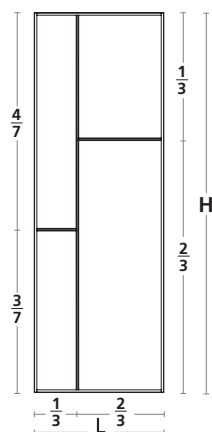

codice  
code  
**SSJFP03D**

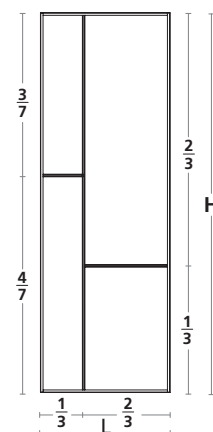

codice  
code  
**SSJFP04D**

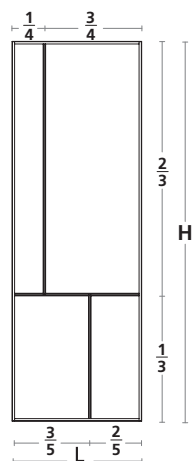

codice  
code  
**SSJFP05D**

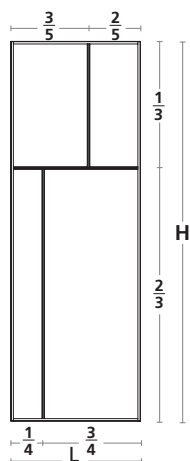

codice  
code  
**SSJFP06D**

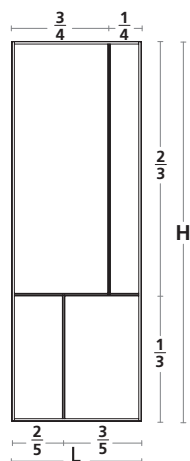

codice  
code  
**SSJFP07D**

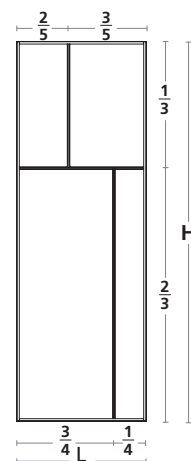

codice  
code  
**SSJFP08D**

# SHERAZADE

Design Piero Lissoni

## SHERAZADE DOUBLE SWING SLIM JAMBS PATCHWORK

### CONFIGURAZIONE PORTA BATTENTE / CONFIGURATION SWING DOOR

opzioni seconda  
anta  $L \leq 599$  mm /  
second door panel  
option  $L \leq 599$  mm

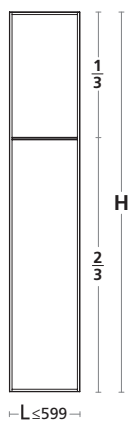

codice  
code  
**SSJFP09D**



codice  
code  
**SSJFP10D**

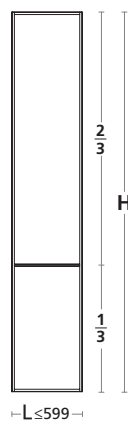

codice  
code  
**SSJFP11D**

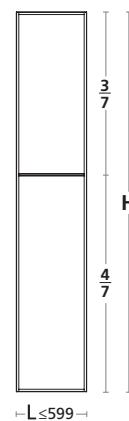

codice  
code  
**SSJFP12D**

# SHERAZADE

Design Piero Lissoni

## SHERAZADE DOUBLE SWING SLIM JAMBS PATCHWORK

### MANIGLIE PORTA DOPPIO BATTENTE / HANDLES DOUBLE SWING DOOR

Maniglia senza blocco /  
Handle without block

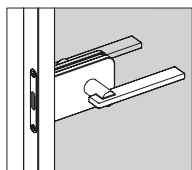

codice  
code  
LSSBA

Maniglia con cilindro /  
Handle with cylinder lock

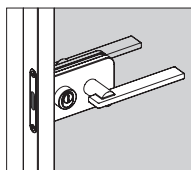

codice  
code  
LSCYA

Maniglia con nottolino A /  
Handle with revolving plug A

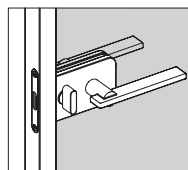

codice  
code  
LSCNA

Maniglia con nottolino B /  
Handle with revolving plug B

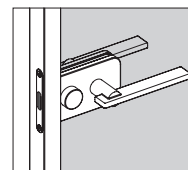

codice  
code  
LSCNNA

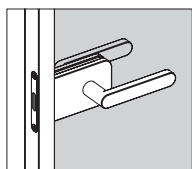

codice  
code  
LSSBB

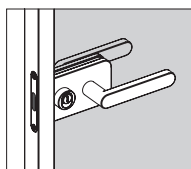

codice  
code  
LSCYB

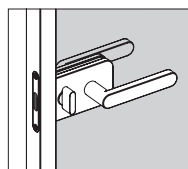

codice  
code  
LSCNB

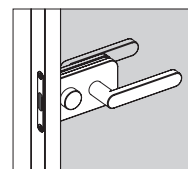

codice  
code  
LSCNNB

### POMOLI PORTA DOPPIO BATTENTE / KNOBS DOUBLE SWING DOOR

Pomolo senza blocco /  
Knob without block

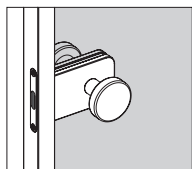

codice  
code  
PSSB

Pomolo con cilindro /  
Knob with cylinder lock

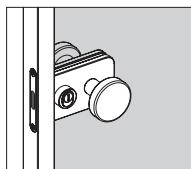

codice  
code  
PSCY

Pomolo con nottolino A /  
Knob with revolving plug A

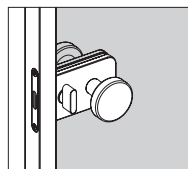

codice  
code  
PSCN

Pomolo con nottolino B /  
Knob with revolving plug B

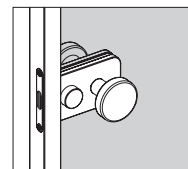

codice  
code  
PSCNN